

ELEVATION
1/2" = 1'-0"

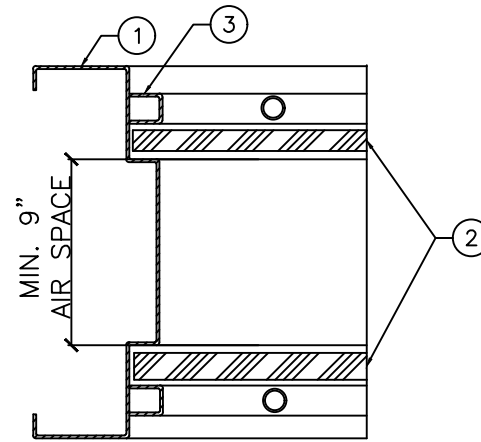

DETAIL "B"
3"-0" = 1'-0"

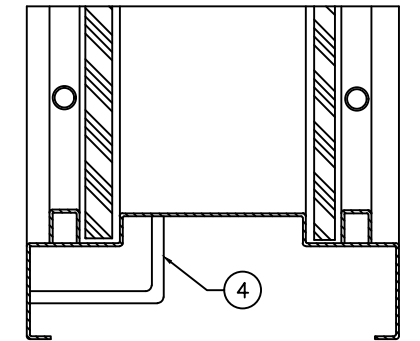
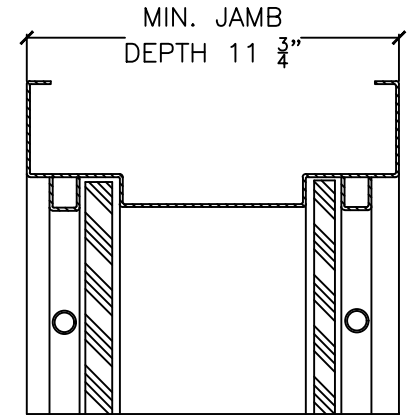

DETAIL "C"
3"-0" = 1'-0"

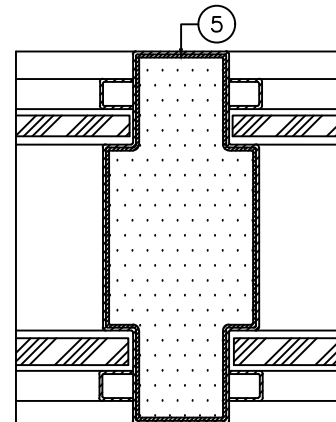

DETAIL "A"
3"-0" = 1'-0"

LEGEND:

1. ACOUSTIC STEEL FRAME
2. CLEAR ACOUSTIC LAMINATED GLASS
3. REMOVABLE GLAZING BEADS
4. PURGE PORTS - 4 PLACES
5. ACOUSTIC LINING



DRAWING TITLE:

ACOUSTIC BORROWED LITE - SINGLE UNIT
STC 56

DATE: -

DRAWN BY: -

REVISION: